

# Connector, strip to strip

Connector, strip to strip, 4pin SMD 10mm, 180° (5-pk)

NOR DESIGN

NorDesign AS  
www.nordesign.no / tlf: 73 84 95 50

Art. nr. 310922105  
GTIN 7070952133999

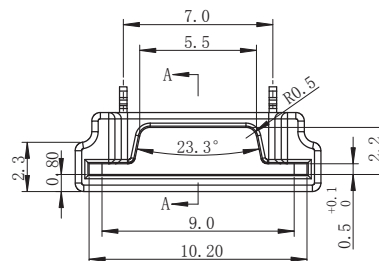
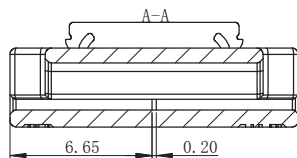
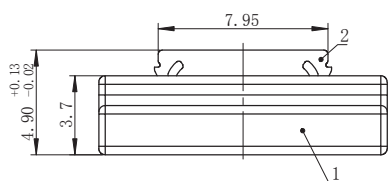
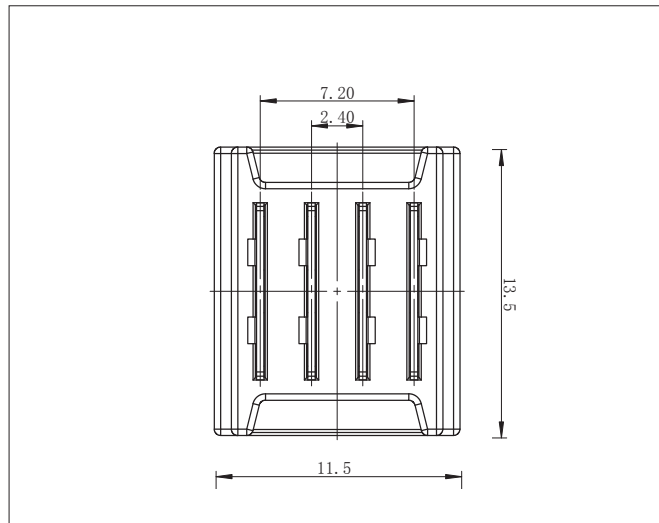

## PRODUKT

Strøm	4A maks.
Volt	12V / 24V / 48V DC
Driftstemperatur	-20°C - +80°C
Kompatibel med	IP20 SMD RGB
PCB	10mm
Materiale	Polykarbonat (transparent)

IP20 RGB



## MONTASJE

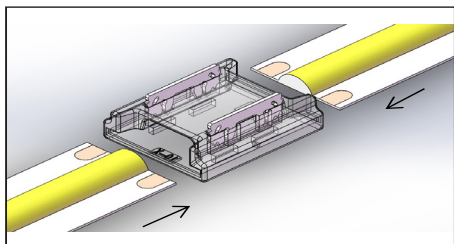

Skv endene på LED-stripene som skal skjøtes sammen inn i skjøtestykket. Sørg for at RGB på LED-strip er lik på hver side.

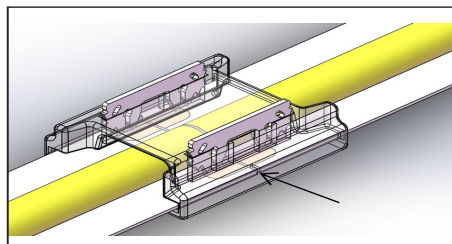

Sørg for at LED-stripene møtes på midten av skjøtestykket.

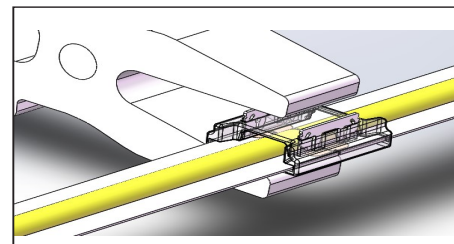

Benytt spesialtilpasset nebbtang til å presse ned metallklemmene. Press jevnt ned og ta en side om gangen.

NB! Ta av tape på undersiden av LED-strip før de føres inn i skjøtestykket.